

# Iacoli & McAllister

## 9 PIECE FRAME CLUSTER

4 Medium Frame Lights

5 Small Frame Lights

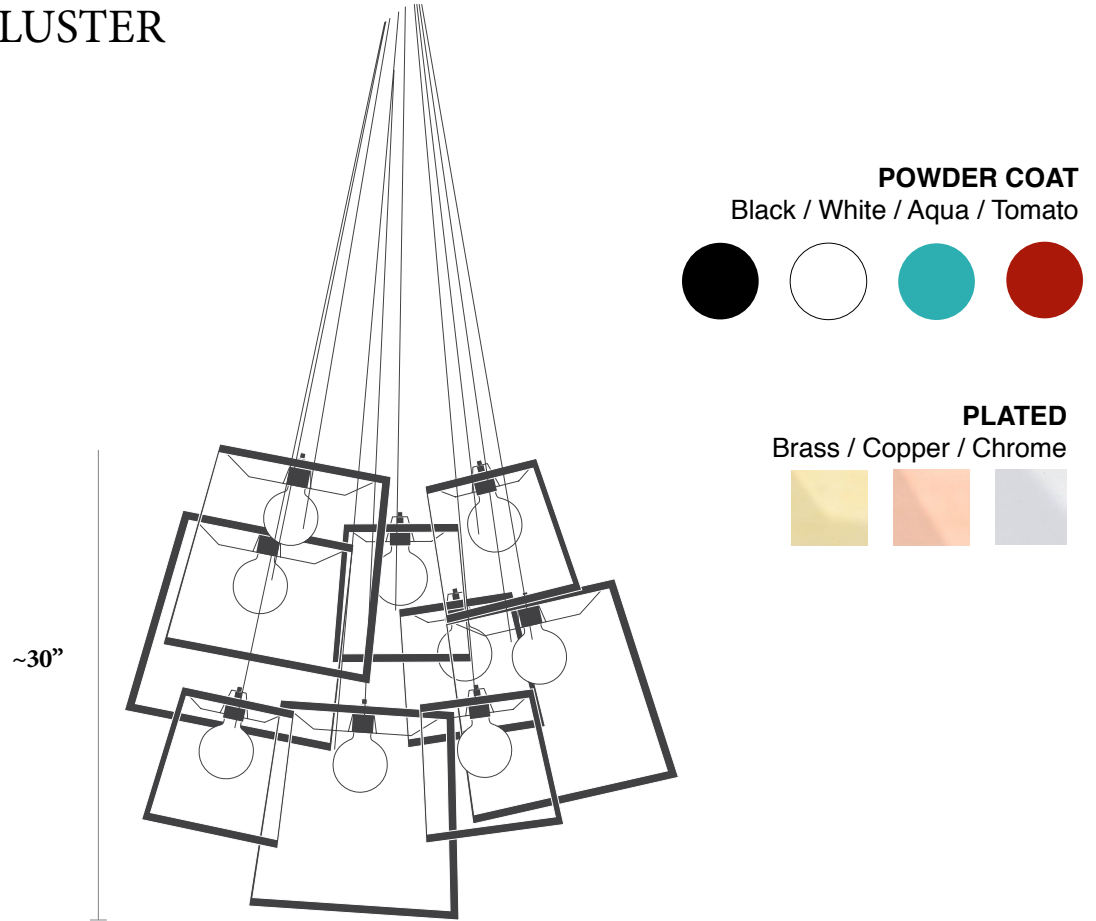

### Materials / Finishes

Powder coated or plated steel pendant.  
Textile electrical cable.

### Year Designed

2011

### Country of Manufacture

United States

### Dimensions

Approx. 36" x 36" x 40"  
Dimensions depend on hanging composition.

### Weight

23 lbs / 10.43 kg

### Bulb

3" white globe  
100 watt bulb / dimmer recommended  
60 watt or lower / no dimmer

### Certification

UL and cUL listed.  
To specify 270 volt fixtures for commercial projects,  
please inquire.

### Product Codes

#### *Powder Coated*

9FrmCl-1101 Black Fixture / White Cord  
9FrmCl-1102 Black Fixture / Black Cord  
9FrmCl-1103 White Fixture / White Cord  
9FrmCl-1104 Aqua Fixture / White Cord  
9FrmCl-1105 Tomato Fixture / White Cord

#### *Plated*

9FrmCl-1111 Brass Fixture / White Cord  
9FrmCl-1112 Brass Fixture / Black Cord  
9FrmCl-1113 Copper Fixture / White Cord  
9FrmCl-1114 Copper Fixture / Black Cord  
9FrmCl-1115 Chrome Fixture / White Cord  
9FrmCl-1116 Chrome Fixture / Black Cord



\*Please note that the UL sticker is on  
the INSIDE of the canopy.

# Iacoli & McAllister

## 9 PIECE FRAME CLUSTER PACKING LIST & SPECS

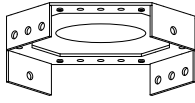

\* Confirm that the mounting bracket will be mounted securely into wood blocking or determine the appropriate hardware for mounting a 33 lb. fixture in your ceiling type.

1. Disconnect power to fixture.
2. Determine and mark mounting bracket plate position.\*
3. Anchor mounting bracket.
4. If necessary, use provided 12 gauge pigtails and wire nuts to lengthen existing wiring in electrical junction box.

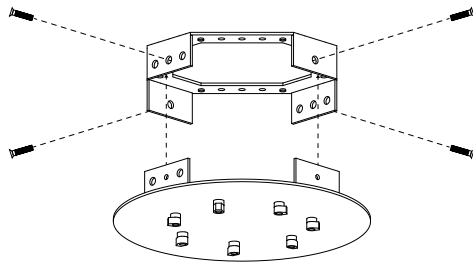

5. Secure canopy to mounting bracket using the provided screws. Route pigtails to one of the open sides of the mounting bracket.

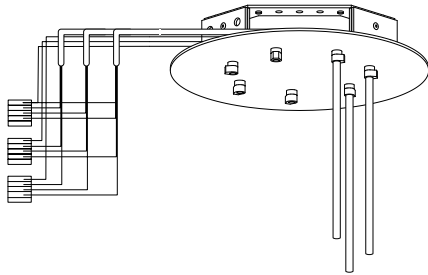
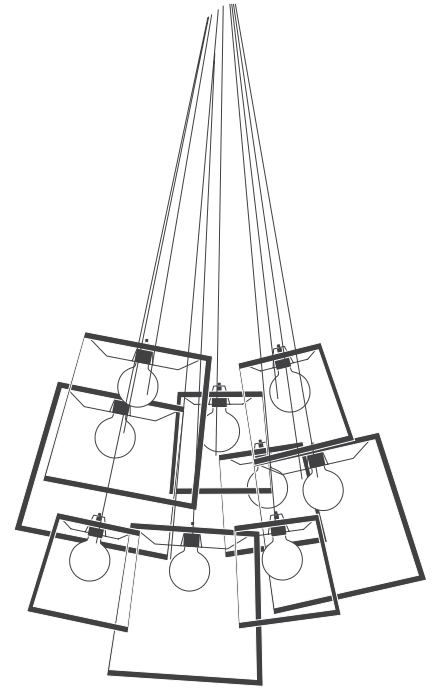

6. Feed each pendant cord through cord grip, pulling extra length to open side of canopy; lock into position with set screw on cord grip. When all pendants are in position\* cut extra length from pendants so that twelve inches extend from the open side of the canopy.
7. canopy.

Strip outer sheathing from each pendant cord. Strip the ends of each black, white and green wire to 10mm or 0.37" of bare copper. Make connections as shown in wiring diagram; black wires to the hot wire, white wires to neutral and green wires to ground.

\*Work with your designer on the ground through this process to establish the final cluster arrangement.

8. When all electrical connections have been made, gently coil the wiring inside the canopy.
9. Install both cover plates.

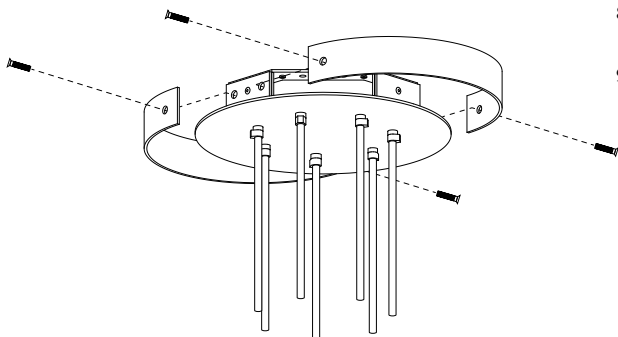

\*Please note that the UL sticker is on the INSIDE of the canopy.

# Iacoli & McAllister

## 9 PIECE FRAME CLUSTER INSTALLATION INSTRUCTIONS

CANOPY DIMENSIONS  
10" DIAMETER x 1 5/8" DEPTH

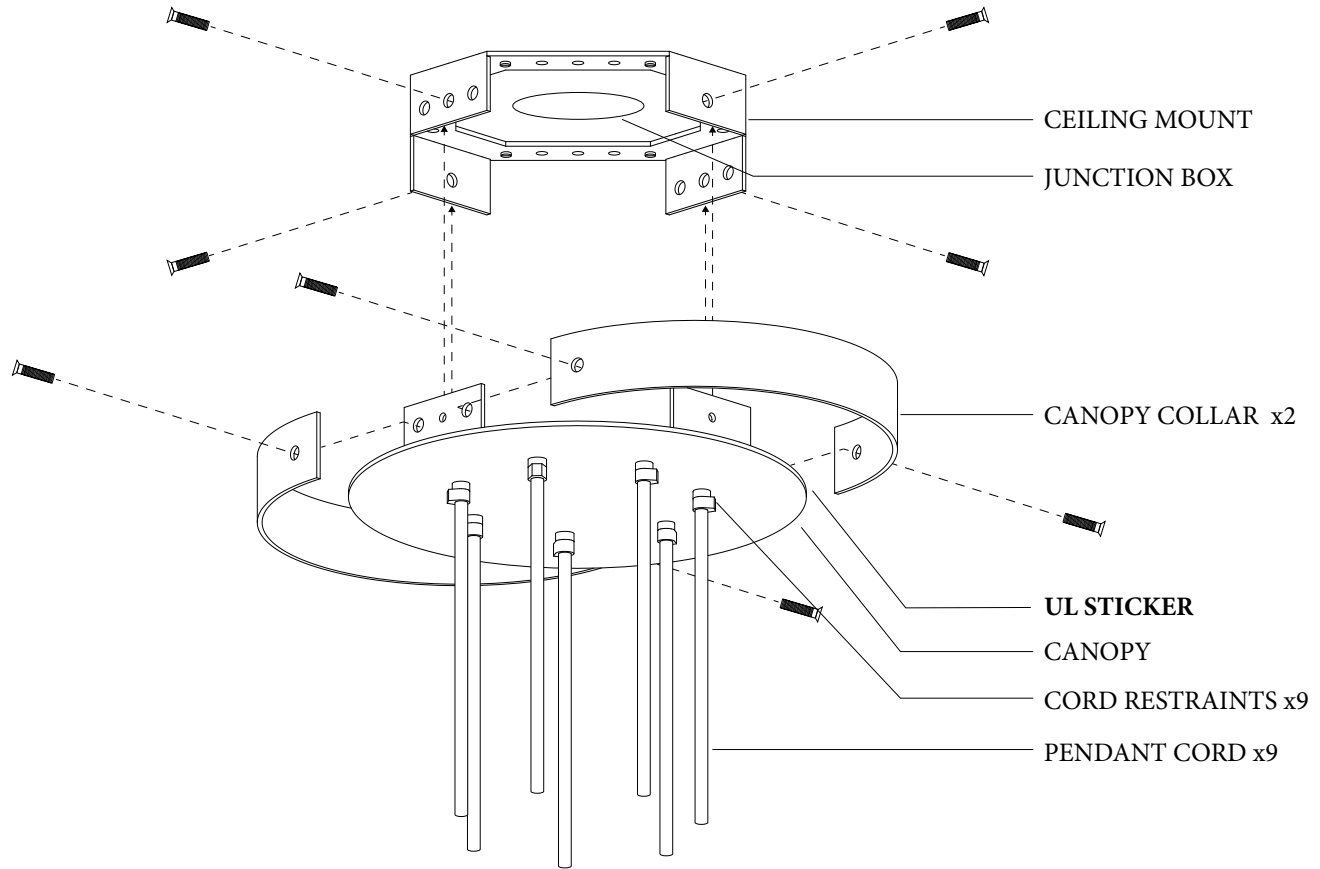

GREEN/COPPER = GROUND  
BLACK = HOT OR POSITIVE  
WHITE = NEUTRAL

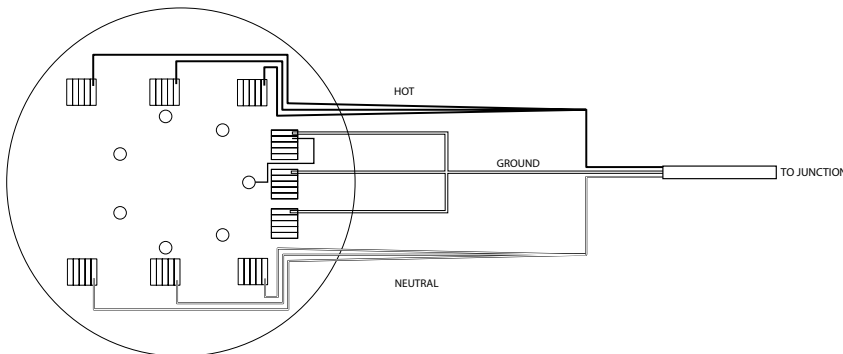

\*\*Diagram is for reference only.  
Actual amount of wires and Wago  
wire nuts may vary according to cluster  
configuration.



\*Please note that the UL sticker is on  
the **INSIDE** of the canopy.